

Article number: 201058316
Description: E+G Handwheel
GN 949-160-K16-D

Measures

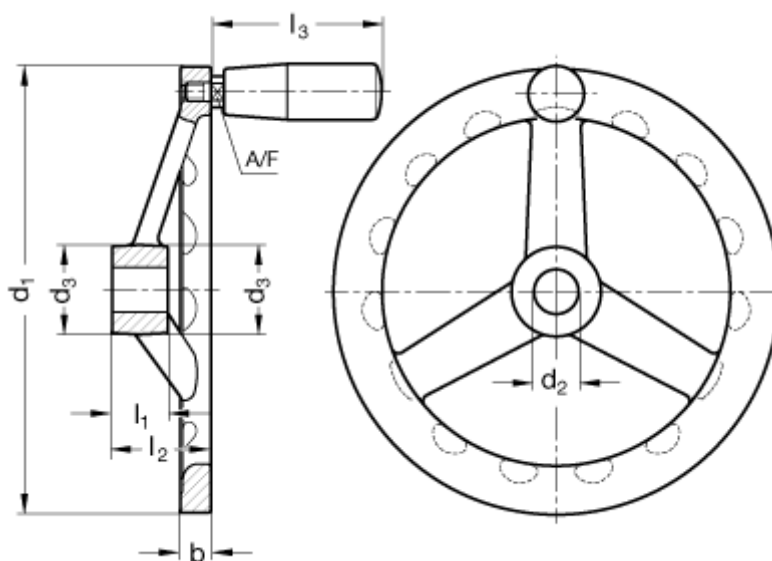

A/F	= 11	l3	= 71
b	= 11	Number of spokes	= 3
d1	= 160		
d2	= 16		
d3	= 31		
Handle diameter	= 23		
l1	= 20		
l2	= 35,5		